

# E3901i / E3902i Induction Boiling Tops

## USER INSTRUCTIONS



**CAUTION - READ THESE INSTRUCTIONS BEFORE USING THIS APPLIANCE!**

- Section 1 – **GENERAL DESCRIPTION**
- Section 2 – **SAFETY and OPERATION**
- Section 3 – **COOKING HINTS**
- Section 4 – **CLEANING and MAINTENANCE**
- Section 5 – **TROUBLESHOOTING**

**This appliance has been UKCA/CE marked based on compliance with the relevant Electrical and Electromagnetic Compatibility (EMC) Regulations/Directives for the voltages stated on the data plate.**

The appliance **MUST BE** installed by a competent person in compliance with the **INSTALLATION AND SERVICING INSTRUCTIONS** and National Regulations in force at the time.

UK regulations are listed on the front of the Installation and Servicing Instructions.

Regular servicing by a qualified person is recommended to ensure the continued safe and efficient performance of the appliance.

**WARNING - THE APPLIANCE MUST BE EARTHED.**

**WARNING - PERSONS WITH PACEMAKERS SHOULD CONSULT THEIR G.P. BEFORE OPERATING THIS APPLIANCE. THIS UNIT OPERATES AT 18 - 22KHz AND THIS MAY AFFECT OLDER TYPES OF PACEMAKER.**

**ENSURE ALL POT/PAN BASES ARE FLAT AND CLEAN PRIOR TO USE.**

**THE AIR INTAKE FILTER MUST BE CLEANED REGULARLY TO REMOVE POTENTIAL OBSTRUCTIONS.**

Upon receipt of the User's Instruction manual, the installer should instruct the responsible person(s) of the correct operation and maintenance of the unit.



**WEEE Directive Registration No. WEE/DC0059TT/PRO**

At end of unit life, dispose of appliance and any replacement parts in a safe manner, via a licenced waste handler.

Units are designed to be dismantled easily and recycling of all material is encouraged whenever practicable.

### **Falcon Foodservice Equipment**

#### **HEAD OFFICE AND WORKS**

Wallace View, Hillfoots Road, Stirling. FK9 5PY. Scotland.

#### **SERVICELINE CONTACT**

Phone: 01438 363 000

Fax: 01438 369 900

T100803 Ref.5

## SECTION 1 - GENERAL DESCRIPTION

2 x individually controlled, marked cooking zones on a glass-ceramic cooktop, mounted on feet.



Figure 1

## SECTION 2 - SAFETY and OPERATION



### WARNING

**IF GLASS-CERAMIC TOP IS CRACKED OR BROKEN, IMMEDIATELY DISCONNECT APPLIANCE FROM POWER SUPPLY AND CONTACT YOUR SERVICE AGENT.**

### WARNING

**PERSONS WITH PACEMAKERS SHOULD CONSULT THEIR G.P. BEFORE OPERATING THIS APPLIANCE. THIS UNIT OPERATES AT 18 - 22KHz AND THIS MAY AFFECT OLDER TYPES OF PACEMAKER.**

The air intake filter **MUST** be in position during operation. It should also be cleaned regularly.

DO NOT obstruct air filter entry below front of appliance or flue exit at rear.

This unit must be installed by a suitably qualified person.

A mains input connecting cable is not supplied with the unit. Suitable cables should be provided by the installer.

**Use of the correct type of pan is essential for correct operation (*Refer to Section 3*).**

**Do not place any metal objects, such as kitchen utensils, cutlery, aluminium foil, or plastic vessels, on the glass- ceramic top.**

Items such as rings, watches, bracelets etc worn by the user could become hot when in close proximity to the cooking zone.

Do not place credit cards, etc. on the glass-ceramic top as data could be wiped off.

Never leave the induction hob unsupervised when in use. The glass-ceramic top must **NOT** be used for storage. Do not place cloths etc. over appliance rear. This may impede flue outlet and cause overheating of appliance.

### OPERATION

Use of the correct pan type is essential for correct operation.

Suitable pans are those made with ferrous materials, ie, ferrous stainless steel, steel. Use a magnet to check; if magnet sticks to the base, the pan should be ok to use.



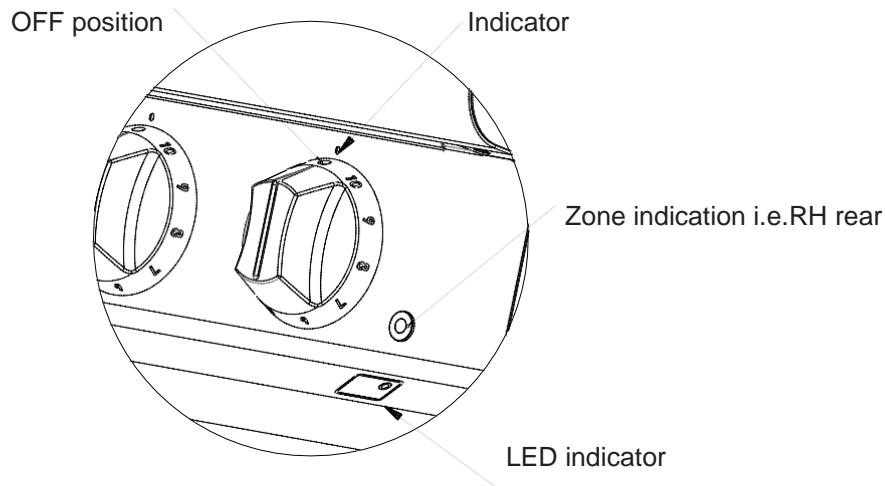
**Warning – *this only tests function – not quality!***

Always place pans centrally on the cooking zone for optimum performance and safety.

Optimum pan diameter is **270mm**.

Do not use pans of less than **120mm** diameter

Each cooking zone is controlled by a marked, variable control from 1 (lowest) to 10 (highest). The ideal setting for simmering or fast boiling pans of varying size will quickly be established through experience. See Figure 2. Each control has a green LED indicator.



**Figure 2.**

When a cooking zone is switched on, the LED indicator will light and stay lit during heating/cooking. If a pan is removed from the zone, the LED will flash approximately once per second. This will indicate that the cooking zone is still active and is awaiting detection of a pan.

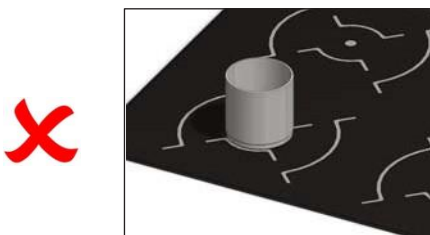
Each cooking zone is controlled by a marked, variable control from 1 (lowest) to 10 (highest). The ideal setting for simmering or fast boiling pans of varying size will quickly be established through experience. See Figure 2. Each control has a green LED indicator.

Each cooking zone is controlled by a marked, variable control from 1 (lowest) to 10 (highest). The ideal setting for simmering or fast boiling pans of varying size will quickly be established through experience. See Figure 2. Each control has a green LED indicator.

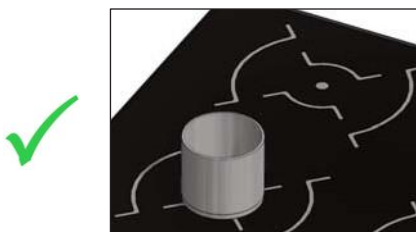


**After use, switch off cooking zones by returning the control to the OFF position. DO NOT rely on the pan detector or safety features to isolate cooking zone.**

A guide to the correct use of pans and cooking zones is listed below:-



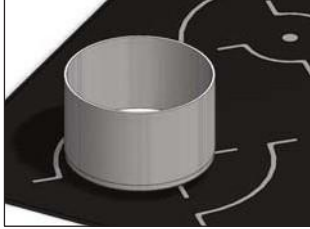
**Figure 3 Unit will not Operate**  
**Ø110mm pan** - If inner circle markings can be seen, the pan is too small. Detection will prevent cooking using this size of pan.



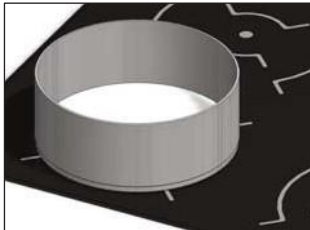
**Figure 4 Unit will Operate**  
**Ø120mm pan** - Pan is ideal, positioned centrally. Inner circle markings cannot be seen  
**Note:** Positioning lines are available for central positioning of pan.



**Figure 5 Unit will not Operate**  
**Ø120mm pan** - Pan is ideal however it is positioned incorrectly. Only half the pan will cook as the outer circle markings have been compromised.

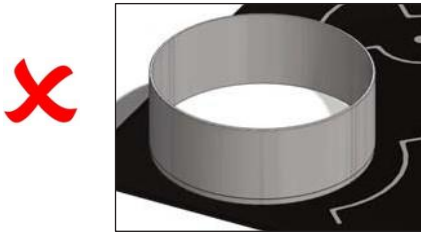


**Figure 6 Unit will Operate however:**  
**Ø180mm pan** - Pan is ideal for cooking. Although pot is positioned incorrectly the whole pan area will cook. Outer circle markings have not been compromised. (THIS IS NOT GOOD PRACTICE)

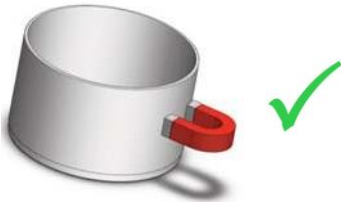


**Figure 7 Unit will Operate**  
**Ø270mm pan** - Pan is ideal for cooking and is positioned centrally.  
Note: Positioning lines available for centralising of pot

A guide to the correct use of pans and cooking zones (continued)



**Figure 8 Unit will Operate however:**  
**Ø270mm pan** - Pan is ideal for cooking but is positioned incorrectly. Only three-quarters of pan will cook as outer circle markings have been compromised.



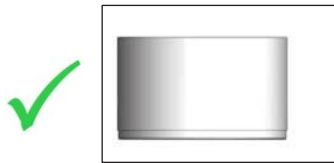
**Figure 9**



**Figure 10**

**Note:** A good pan is made of ferrous material and therefore is magnetic so that it reacts to the magnetic induction field. Ensure pots are magnetic or induction approved.

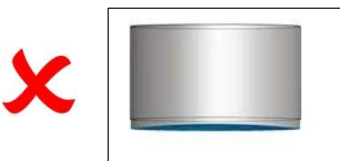
If a pan base is damaged or warped, ie concave or convex, discontinue use or replace as this could seriously affect performance, refer to diagrams below.



**Figure 11** Pan base is FLAT and ideal for Cooking.  
**Note:** Pans should be kept clean and free from damage. Dirty, damaged pans affect efficiency of cooking.



**Figure 12** Pan base is bowed out and is **NOT FLAT**. The unit efficiency will be dramatically reduced during cooking. It may not even be detected by the appliance.  
**Note:** This is also liable to happen if pans are damaged, e.g. large dents.



**Figure 13** Pot base is bowed inward and is **NOT FLAT**; The unit efficiency will be dramatically reduced during cooking. It may not even be detected by the appliance.  
**Note:** This is also liable to happen if pans are damaged, e.g. large dents.



**Figure 14** Excessive food spillage stuck to pan base will impinge the pan balance. One side of the utensil will be further away from the induction field than the other. This could reduce efficiency and it will also cook one side of the pan faster. Keep pans clean to ensure efficient cooking.



Three instances marked thus will cause the generator to overheat and cut out.  
If this occurs, turn off power. The generator will re-set when temperature turns down.

## SECTION 3 - COOKING HINTS

1. Before use, ensure that hob surface is clean, dry and free of grease. Remove any burnt on food debris.
2. Familiarise yourself with the cooking area and the control settings.
3. Each cooking zone has a power capacity of 3.5kW or 5kW.
4. Each zone is governed by an individual energy regulator.
5. Control setting is from 1 to 10. (1 - lowest setting and 10 - highest).
6. Boiling, steaming, poaching, stewing, pot roasting, deep and shallow frying can be carried out using the induction hob.
7. It is advisable to use ferritic cooking vessels.
8. To boil liquid, follow this procedure:  
Fill and position pan centrally within cooking zone. Turn appropriate switch dial to 10.  
When boiling occurs, reduce setting and continue to cook by simmering
9. The lower setting is dependent on amount and density of liquid and also starch content.
10. Skill is required to control simmering and the ability to select a corresponding temperature setting will improve with practice.
11. Any spillages should be cleaned from hob surface as soon as practically possible.

## SECTION 4 - CLEANING and MAINTENANCE

**It is important to clean the air intake filter regularly.**

The filter is located below body at front centre. It can be removed by sliding out of the front. Clean using hot, soapy water and re-fit after drying. (Refer to Figure 5) Failure to clean the filter regularly may cause problems which will not be covered by warranty.

**The air intake filter MUST be in place during operation!**

The glass-ceramic top can be wiped clean using a damp cloth and warm, soapy water. For heavy stains, use a scraper whilst cooking zone is still warm then wipe down when cool with a damp cloth.

NEVER USE a spray jet to clean this appliance.

### ERROR CODES

DO NOT remove or attempt to repair or replace ANY part or parts of this appliance other than the air intake filter.

If an error occurs within the unit, the control panel LEDs will flash to indicate an error code.

There will be one long flash followed by a series of shorter flashes. The number of "short" flashes corresponds to the number in the "code" column of the Error Code Table - ie. 5 short flashes corresponds to error code **05 - Control Unit Failure**.

The error code list on pages 7 and 8 will help identify the faulty component.

In the "action by user" list, you should follow the action listed, **before contacting a Service Engineer**.

### Key to unit symbols



Non-ionizing, electro-magnetic radiation.



Dangerous voltage

Equipotentiality



## SECTION 5 - TROUBLESHOOTING

### SUPPLY PROTECTION DEVICE

The appliance is fitted with a miniature circuit breaker (*MCB*) as additional protection against over current. If unit fails to operate or show any operational indicators, Follow details in Error Code Table before calling a service engineer. The symptoms may indicate a failed induction generator

### ERROR CODES

DO NOT remove or attempt to repair or replace ANY part or parts of this appliance other than the air intake filter.

If an error occurs within the unit, the control panel LEDs will flash to indicate an error code.

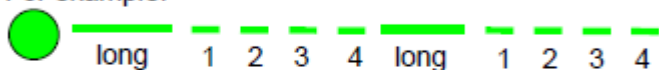
The error code list that follows will help identify the faulty component.

In the "action by user" list, you should follow the action listed, **before contacting a Service Engineer.**

There are two different error types:

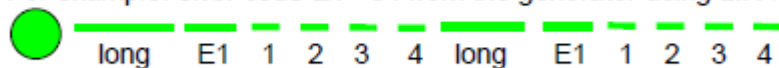
- Generator errors (E1)
- Digital control errors(E2)

**Generator errors** are faults detected by the generator, faults can be detected according to the duration and frequency of the green light blinking. When using potentiometer knob, the green lamp lights one time long and then short regular flashes. For example:

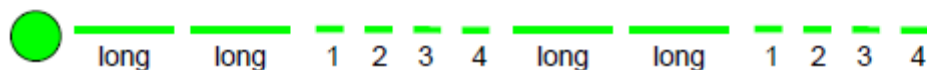


When using LIN knob, the green lamp lights one time long, one medium flash (E1) and then short regular flashes. The number of these short flashes is the error number. This pattern is constantly repeated.

For example: error code E1 - 04 from the generator using LIN knob:



**Digital control errors** are faults from the digital controls. On the display appears "E2", the green lamp lights two times long and then short regular flashes. The number of these short error flashes is the error number. The pattern is constantly repeated.



**Note:** Most faults can be rectified by simply switching the unit off for 10 seconds. After this time, turn the power back on at mains supply. If the fault continues to occur after this action then please refer to the table. The following codes can be assessed by the user; any others will require a service engineer.

<b>Error</b>	<b>Name</b>	<b>Cause</b>	<b>Corrective action</b>
<b>E1-04</b>	<b>Cooking zone temperature too high.</b>	Pan empty	Remove pan, switch off Appliance and wait a couple of minutes for the appliance to cool
<b>E1-06</b>	<b>Internal Temperature too high</b>	Air routes blocked.	Switch off appliance, clean air units
<b>E1-07</b>	<b>Coil Temperature.</b>	Coil temperature too high.	Remove pan, switch off appliance for a couple of minutes.
<b>E1-15</b>	<b>Empty Pan protection.</b>	Empty Pan.	Remove pan, switch off and wait for a couple of minutes until the cooking field has cooled down.