



OE8413 - Lincat Opus 800  
Electric Counter-top  
Direct Cook Chargrill - W  
600 mm - 8.4 kW

Create perfectly cooked, expertly  
branded burgers and steaks

- ✓ Food cooked directly on elements, so no need for separate branding bars
- ✓ Consistent temperature across whole cooking area
- ✓ Powerful elements with rapid heat up
- ✓ Temperature range from 90°C to 400°C
- ✓ Removable tank liner for easy cleaning
- ✓ No water connection required

Specifications

Summary

<b>Brand</b>	Lincat
<b>Range</b>	Opus 800
<b>Power Type</b>	Electric
<b>Unit Type</b>	Counter-top
<b>Available in UK Only</b>	No
<b>UK Warranty</b>	2 Years Parts and Labour Warranty
<b>Export Warranty</b>	Contact your local dealer
<b>GTIN</b>	5056105118343

Power and Performance

<b>Total Power kW</b>	8.40
<b>Temperature Range °C</b>	90-400
<b>IP Rating</b>	IPX4
<b>Cooking Area (Width x Depth) mm</b>	450 x 590
<b>Temperature Control</b>	Mechanical

Key Specifications

<b>Number of Heat Zones</b>	1
-----------------------------	---

Weights and Dimensions

<b>Unit Height (External) mm</b>	592
<b>Unit Width (External) mm</b>	600
<b>Unit Depth (External) mm</b>	800
<b>Net Weight Kg</b>	58.1

Supply Connections

<b>Requires Installation</b>	Yes
<b>Requires Electrical Supply</b>	Yes
<b>UK 3 Pin Plug</b>	No
<b>Requires Hardwiring</b>	Yes
<b>Electrical Supply Rating Watts</b>	8,400
<b>Three Phase Amps</b>	L1=11; L2=11; L3=15
<b>Three Phase Voltage</b>	400

Shipping

<b>Packed Weight Kg</b>	68.5
<b>Packed Height cm</b>	75
<b>Packed Width cm</b>	70
<b>Packed Depth cm</b>	85

Available Accessories

<b>OA8989</b>	HOLDING SHELF FOR OG8401 & OG8403
<b>OA8991</b>	Lincat Opus 800 Free-standing Floor Stand with Legs - for Synergy Grill W 600 mm
<b>OA8991/C</b>	Lincat Opus 800 Free-standing Floor Stand with Castors - for Synergy Grill W 600 mm
<b>OA9002</b>	NULL

Technical Picture

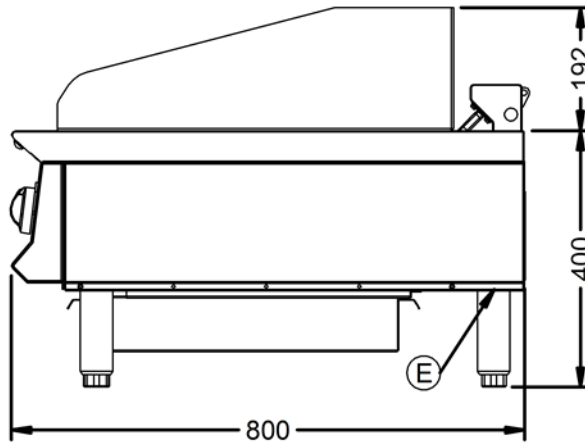
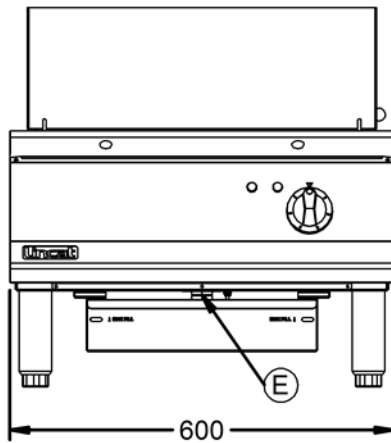
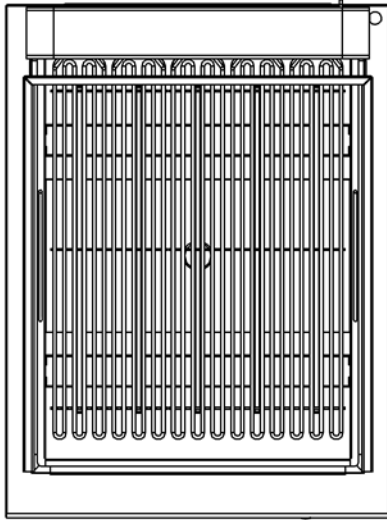

**Lincat Limited**

Whisby Road,  
Lincoln, LN6 3QZ,  
United Kingdom

**Company No:** 2175448

A member company of



**Customer Care**

**Tel:** +44 1522 875500  
**Email:** care@lincat.co.uk

**Export Customers**

**Tel:** +44 1522 875536  
**Email:** export@lincat.co.uk

**Opening Hours**

**Monday – Friday:**  
8.30am – 5pm