

TECHNICAL DATA

Weight:	550 kg
Grill rack dimensions:	2 x 650 x 735 mm
Top rack dimensions:	2 x 685 x 305 mm
Grill rack hub:	338mm (Grill rack at 25°) 390mm (Grill rack at 0°)
Grill rack inclinations:	0°; 6,25°; 12,5°; 18,75°; 25°
Fire pit material:	Refractory bricks
Exhaust rate:	4.800 m3/h
Average charcoal consuption:	31-35 kg

STANDARD EQUIPMENT

V-groove Rack insert - 4x
Upper Grill - 2x
Kopa poker
Kopa ash shovel
Kopa Tong

OPTIONAL EQUIPMENT

V-Groove insert:	325 x 735 mm
Round bar insert:	325 x 735 mm
Plancha insert:	325 x 735 mm
Perforated plancha insert:	325 x 735 mm

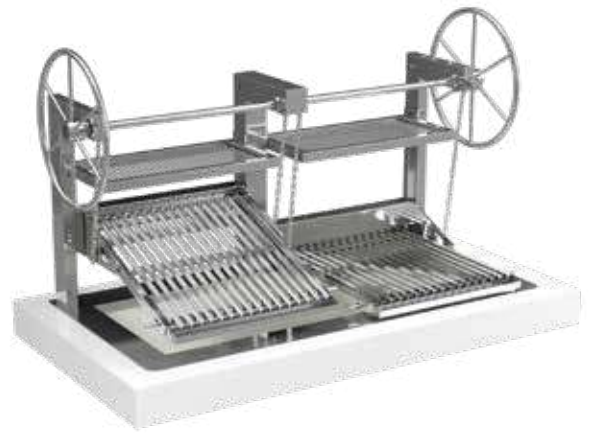

TECHNICAL DRAWINGS

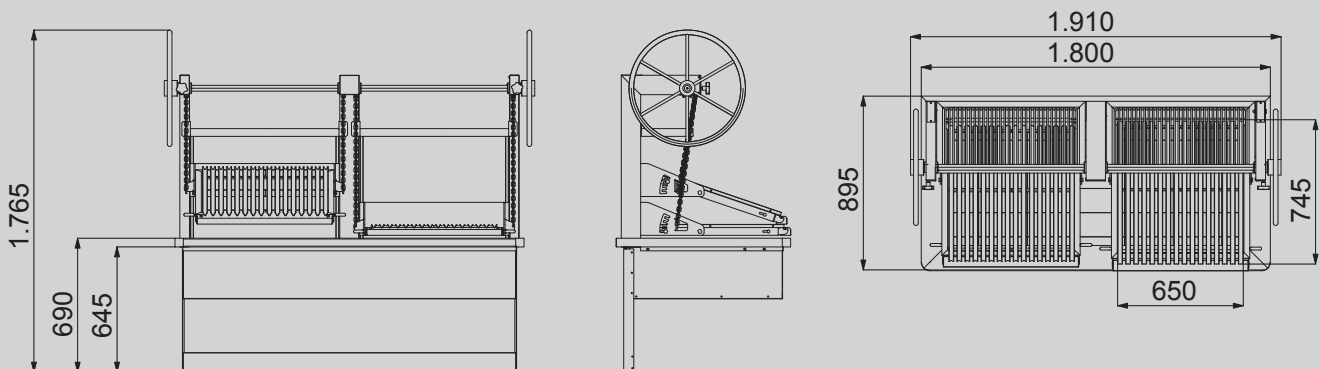

Available in these colors:



Red



Black